

# ACCESSORI



Il bagno Inda continua ad essere grande protagonista  
con nuove soluzioni per gli stili di vita più attuali, attraverso le divisioni di prodotto,  
**Accessori, Pareti doccia, Mobili e Specchi**  
infinite soluzioni d'arredamento che permettono di coniugare l'innovazione nel design  
e nelle funzionalità con gli spazi delle case di oggi.

**Inda, per voi il presente ed il futuro del bagno!**

Inda bath-room keeps on being a leading actor,  
with new solutions for most current lifestyles through its categories of products  
– **Accessories, Shower Enclosures, Furniture and Mirrors** –  
limitless solutions of interior design which allow to combine design and functionality innovation  
with the spaces of present-day houses.

**Inda, to you the present and the future of the bathroom!**

8\_ **SCOPINI UNIVERSALI**  
Universal brushes  
Escobillas universales  
Porte-balais transversaux  
Universele toiletborstelgarnituren  
Wc-bürstengarnituren universal

26\_ **ELLEPI**  
32\_ **EGO**  
40\_ **CONFORT**  
48\_ **NEW EUROPE**  
54\_ **DIVO**  
60\_ **MITO**  
68\_ **GEALUNA**  
76\_ **LEA**  
84\_ **HOTELLERIE**

92\_ **QUALITÀ CERTIFICATA**  
Certified quality  
Qualité certifiée  
Calidad certificada  
Kwaliteitscertificaten  
Qualitätsnachweise

94\_ **FINITURE**  
Finishes  
Acabados  
Finitions  
Afwerkingen  
Ausführungen

98\_ **LEGENDA SIMBOLIS**  
Symbol key  
Leyenda símbolo  
Leyenda símbolos  
Verklaring symbolen  
Zeichenerklärung

#### 4\_ AZIENDA / COMPANY

Storia imprenditoriale tutta italiana quella di Inda, Gruppo Industriale del settore arredobagno con una consolidata leadership nei mercati internazionali, più di 70 anni d'esperienza al servizio della propria clientela basata su di una profonda capacità di cogliere le esigenze ed i gusti di un pubblico eterogeneo in continuo cambiamento ed anticipare le tendenze dell'abitare. Quattro le divisioni di prodotto del Gruppo, Mobili, Pareti doccia, Accessori e Specchi che formano in realtà un pensiero unico, ideale per infinite soluzioni d'arredamento della sala da bagno. Creatività, originalità, distintiva eleganza sono elementi caratterizzanti che si esprimono nel design Inda attraverso tutte le sue forme, dal classico, al moderno alle soluzioni più all'avanguardia che rispondono tempestivamente all'evoluzione dell'abitare. Un progetto globale che si declina in ogni situazione architettonica grazie all'eccezionale versatilità e dedica le proprie risorse creative e produttive anche all'attività, parallela e complementare, delle grandi forniture internazionali.

Inda the story of a successful Italian company driven by a true entrepreneurial spirit. Inda is an industrial group with a well established leadership in the international markets, more than 70 years of experience dedicated to the support of the customers, the expertise of Inda is based on a deep competence to learn and to understand the needs and the tastes of the diverse markets which change and evolve continuously. The Inda purpose is to anticipate the trends of the interior design and contemporary living. The company offers four categories of products, furniture, shower enclosures, accessories and mirrors which merge together in a unique concept of unlimited solutions for the bathroom interiors. Creativity, originality and distinctive elegance are elements which identify and express the design of Inda through a wide offer of products, from the classic to the modern, until the most avant-garde solutions which promptly respond to the constant evolutions of the nowadays living. A global project which, thanks to its great flexibility, finds space in the different architectural environments, and which complementary and simultaneously invest creative and manufacturing resources also to the supplies of the main international projects.



## 6\_ AZIENDA / COMPANY

### DESIGN

Creatività, originalità e distintiva eleganza sono elementi caratterizzanti che si esprimono nel design Inda attraverso tutte le sue forme, dal classico, al moderno alle soluzioni più all'avanguardia. La Ricerca & Sviluppo Inda si caratterizza come un'area composita, fucina di idee e innovazioni continue. Non solo firme prestigiose ma un laboratorio continuo per giovani designer ed artisti emergenti, in collaborazione con le più prestigiose Accademie ed Università Italiane ed Europee. Una ricerca stilistica continua e sempre mirata ad interpretare al meglio i trend più contemporanei del vivere il bagno e a fornire la massima libertà di accostamento fra proposte diverse.

### INNOVAZIONE

Grazie ad un percorso di ricerca continua all'insegna del design, della funzionalità, della qualità e della dedizione al dettaglio anche attraverso un'ampia gamma di finiture e di colori, tutte peculiarità fortemente riconosciute dal mercato. Inda pone grande attenzione nel selezionare le materie prime utilizzate per realizzare le proprie proposte attraverso una ricerca costante della qualità nei materiali per garantire affidabilità e durata nel tempo.

### QUALITÀ

Tutte le unità operative Inda garantiscono la massima qualità del prodotto finito. Un metodo di lavoro che coniuga attenzione e continua innovazione tecnologica delle linee produttive confermate dalla certificazione del sistema di qualità TÜV in accordo alla normativa UNI EN ISO 9001:2008. La globalità dei processi operativi, dall'acquisizione dell'ordine alla consegna del prodotto, è costantemente sotto controllo. TÜV Italia, garantisce la conformità di Inda agli elevati standard qualitativi imposti dalla certificazione UNI EN ISO 9001. Tutti i prodotti di illuminazione ed elettrici Inda sono conformi alla marcatura CE, passaporto indispensabile per le frontiere dell'Unione Europea.

### DESIGN

Creativity, originality and distinctive elegance are elements which identify and express Inda design through a wide offer of products, from the classic to the modern, until the most avant-garde solutions. Inda Research&Development characterizes itself as a composite area, a breeding ground for ideas and ongoing innovation. Not only prestigious designers but also young designers and emerging artists in collaboration with the most prestigious Italian and European Academies and Universities. An ongoing research into style, always aiming to interpret in the best possible way the most contemporary trends in the bathroom area and offering the freest possible approach to choose from what is on offer.

### INNOVATION

Through an ongoing pursuit of excellence, functionality, quality and attention to the details with a wide offer of finishings and colors: features that are widely acknowledged on the market. Inda pays great attention in selecting the materials through an ongoing research for quality materials, in order to ensure the customer product reliability and durability.

### QUALITY

Each Inda operative unit ensures the highest quality of the final product. A work method that combines attention and continuous technological innovation of the production lines and confirmed by the certification of its TÜV Quality System in accordance with the UNI EN ISO 9001:2008. The whole operating process, from the acquisition of orders to the delivery of the end product is constantly monitored. TÜV Italy, ensures Inda conformity to the highest quality standards in compliance with UNI EN ISO 9001 certification. All Inda electric and lightening products bear the CE marking, necessary passport for the EU frontiers.

# 8\_ **SCOPINI UNIVERSALI**

Universal brushes  
Escobillas universales  
Porte-balais transversaux  
Universele toiletborstelgarnituren  
WC-Bürstengarnituren universal



10\_ MYLOVE



\_11

12\_ MYWAY / 3814 / 3714



\_13



# MYLOVE

New hygenical innovation



AV014A CR  
cm Ø 9 x 40H



AV014A WZ



AV014A WM



AV014A WY



AV014A GE



AV014A CS



AV014A DR

14\_



AV014B CR  
cm Ø 9 x 40H



AV014B NE



AV014B NC



AV014B AC



AV014B CO



AV014B RM



AV014B ML

# 3714

New hygenical innovation



A37140 CR



A37140 CD



A37140 DR



A37140 BZ

\_15

# MYLOVE

New hygenical innovation



Manico e coperchio  
in ottone cromato  
Handle and cover  
in chrome plated brass  
Mango y tapa  
en latón cromado  
Manche et couvercle  
en laiton chromé  
Steel en deksel in  
verchromd messing  
Stiel und Deckel aus  
verchromten Messing

Ogni confezione singola è  
dotata di uno scovolo di  
ricambio  
Every single packet has a  
spare part brush  
Cada paquete individual  
está dotada de un cepillo de  
recambio  
Chaque boîte est doté d'une  
balayette de rechange  
Ledere enkele verpakking  
is uitgerust met een  
vervangende borstelkop  
Jede einzelne Verpackung  
wird mit einer Ersatzbürste  
ausgestattet

Scovolo  
Brush  
Cepillo  
Balayette  
Borstelkop  
Bürste

Imbuto di autocentraggio in  
plastica ABS con trattamento  
antibatterico

Conical self-centering cover in  
ABS plastic with antibacterial  
treatment

Embudo de centrado en  
plastico ABS con tratamiento  
antibacteriano

Embout d'auto-centrage en  
plastique ABS antibactérien

Autocentreer trechter in ABS  
plastic met bacteriëndodende  
behandeling

Selbstschliessender Trichter aus  
ABS Plastik mit antibakteriellen  
Behandlung

Corpo esterno in ottone cromato: il  
design universale si adatta ad ogni  
contesto

Outer part in chrome plated brass:  
the universal design is suitable to any  
ambiente

Cuerpo externo en latón cromado: el  
diseño universal se adapta a cualquier  
contexto

Corps externe en laiton chromé: le  
design universel s'adapte à chaque  
coin wc

Buitenste korpus in verchromd  
messing: het universele design past  
zich aan iedere situatie aan

Aussenteil aus verchromten Messing:  
Dank dem universalen Design passt es  
sich jeder Umgebung an

Base in plastica polipropilene: evita  
il danneggiamento delle superfici e  
garantisce una maggiore silenziosità  
durante l'appoggio

Basement in polypropylene pastic:  
avoid the damaging of surface areas  
and guarantees a quiet set down

Base en plástico polipropileno: evita  
se dañe la superficie y garantiza un  
mayor silencio durante el apoyo

Socle en plastique polypropylène:  
respect des surfaces et silence

Onderkant in polipropyleen plastic:  
vermijdt beschadigingen van de  
oppervlakten en garandeert het  
geluidloos neerzetten van het product

Boden aus Plastik: vermeidet die  
Beschädigung der Bodenoberflächen  
und garantiert eine leises Aufsetzen  
der Garnitur

Fondello estraibile in plastica polipropilene con trattamento antibatterico: trattiene l'acqua di scolo dello scovolo e ne facilita la pulizia  
Removable inner part in polypropylene plastic with antibacterial treatment: collect water from the brush and simplify the cleaning

Fondo extraible en plástico polipropileno con tratamiento antibacteriano: mantiene el agua del drenaje y facilita la limpieza  
Coupelle intérieure amovible en plastique polypropylène antibactérien

Uitneembare bodem in polipropyleen plastic met bacteriëndodende behandeling: deze vangt het weglappende water op en vergemakelijkt de schoonmaak  
de schoonmaak

Herausnehmbares Innenteil aus Polypropylen mit antibakteriellen Behandlung: fängt heruntertropfendes Wasser auf und vereinfacht die Reinigung

AV014A CR



# MYWAY

New hygenical innovation



Manico e coperchio  
in ottone cromato  
Handle and cover  
in chrome paltded brass  
Mango y tapa  
en latón cromado  
Manche et couvercle  
en laiton chromé  
Steel en deksel in  
verchromd messing  
Stiel und Deckel aus  
verchromten Messing

Scovolo  
Brush  
Cepillo  
Balayette  
Borstelkop  
Bürste

Imbuto di autocentraggio in  
plastica ABS con trattamento  
antibatterico

Conical self-centering cover in  
ABS plastic with antibacterial  
treatment

Embudo de centrado en  
plastico ABS con tratamiento  
antibacteriano

Embout d'auto-centrage en  
plastique ABS antibactérien

Autocentreer trechter in ABS  
plastic met bacteriëndodende  
behandeling

Selbstschliessender Trichter  
aus ABS Plastik mit  
antibakteriellen Behandlung

Corpo esterno in ottone cromato: il  
design universale si adatta ad ogni  
contesto

Outer part in chrome plated brass:  
the universal design is suitable to any  
ambiance

Cuerpo externo en latón cromado: el  
diseño universal se adapta a cualquier  
contexto

Corps externe en laiton chromé: le  
design universel s'adapte à chaque  
coin wc

Buitenste korpus in verchromd  
messing: het universele design past  
zich aan iedere situatie aan

Aussenteil aus verchromten Messing:  
Dank dem universalen Design passt es  
sich jeder Umgebung an

Base in plastica polipropilene: evita  
il danneggiamento delle superfici e  
garantisce una maggiore silenziosità  
durante l'appoggio

Basement in polypropylene pastic:  
avoid the damaging of surface areas  
and guarantees a quiet set down

Base en plástico polipropileno: evita  
se dañe la superficie y garantiza un  
mayor silencio durante el apoyo

Socle en plastique polypropylène:  
respect des surfaces et silence

Onderkant in polipropyleen plastic:  
vermijdt beschadigen van de  
oppervlakten en garandeert het  
geluidloos neerzetten van het product

Boden aus Plastik: vermeidet die  
Beschädigung der Bodenoberflächen  
und garantiert eine leises Aufsetzen  
der Garnitur

Fondello estraibile in plastica polipropilene con trattamento antibatterico: trattiene l'acqua di scolo dello scovolo e ne facilita la pulizia  
Removable inner part in polypropylene plastic with antibacterial treatment: collect water from the brush and simplify the cleaning

Fondo extraible en plástico polipropileno con tratamiento antibacteriano: mantiene el agua del drenaje y facilita la limpieza  
Coupelle intérieure amovible en plastique polypropylène antibactérien

Uitneembare bodem in polipropyleen plastic met bacteriëndodende behandeling: deze vangt het weglopende water op en vergemakkelijkt de schoonmaak  
vergemakkelijkt de schoonmaak

Herausnehmbares Innenteil aus Polypropylen mit antibakteriellen Behandlung: fängt heruntertropfendes Wasser auf und vereinfacht die Reinigung

AV114A CR

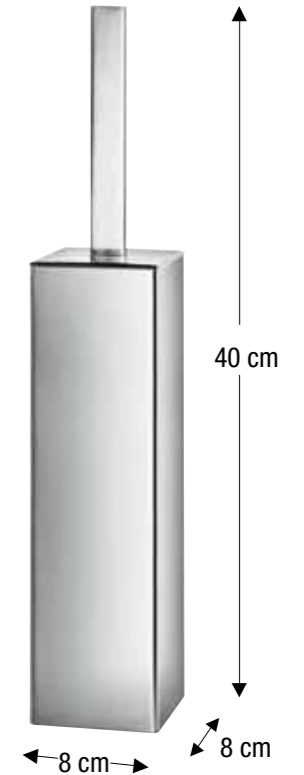

# 3714

New hygenical innovation



Manico e coperchio  
in ottone cromato  
Handle and cover  
in chrome paltd brass  
Mango y tapa  
en latón cromado  
Manche et couvercle  
en laiton chromé  
Steel en deksel in  
verchroomd messing  
Stiel und Deckel aus  
verchromten Messing

Imbuto di autocentraggio in plastica  
ABS con trattamento antibatterico  
Conical self-centering cover in ABS  
plastic with antibacterial treatment  
Embudo de centrado en plastico  
ABS con tratamiento antibacteriano  
Embout d'auto-centrage en  
plastique ABS antibactérien  
Autocentreer trechter in ABS  
plastic met bacteriëndodende  
behandeling  
Selbstschliessender Trichter aus  
ABS Plastik mit antibakteriellen  
Behandlung

Corpo esterno in ottone cromato: il design  
universale si adatta ad ogni contesto  
Outer part in chrome plated brass: the  
universal design is suitable to any ambience  
Cuerpo externo en latón cromado: el diseño  
universal se adapta a cualquier contexto  
Corps externe en laiton chromé: le design  
universel s'adapte à chaque coin wc  
Buitenste korpus in verchroomd messing:  
het universele design past zich aan iedere  
situatie aan  
Aussenteil aus verchromten Messing: Dank  
dem universalen Design passt es sich jeder  
Umgebung an

Base in plastica polipropilene: evita il  
danneggiamento delle superfici e garantisce  
una maggiore silenziosità durante l'appoggio  
Basement in polypropylene pastic: avoid the  
damaging of surface areas and guarantees a  
quiet set down  
Base en plástico polipropileno: evita se dañe  
la superficie y garantiza un mayor silencio  
durante el apoyo  
Socle en plastique polypropylène: respect des  
surfaces et silence  
Onderkant in polipropyleen plastic: vermijdt  
beschadigingen van de oppervlakten en  
garandeert het geluidloos neerzetten van het  
product  
Boden aus Plastik: vermeidet die  
Beschädigung der Bodenoberflächen und  
garantiert eine leises Aufsetzen der Garnitur

scovolo  
brush  
cepillo  
balayette  
borstelkop  
Bürste

**A37140 CR**



# 3814

New hygenical innovation



Manico e coperchio  
in ottone cromato  
Handle and cover  
in chrome plated brass  
Mango y tapa  
en latón cromado  
Manche et couvercle  
en laiton chromé  
Steel en deksel in  
verchromd messing  
Stiel und Deckel aus  
verchromten Messing

Imbuto di autocentraggio in plastica  
ABS con trattamento antibatterico  
Conical self-centering cover in ABS  
plastic with antibacterial treatment  
Embudo de centrado en plastico  
ABS con tratamiento antibacteriano  
Embout d'auto-centrage en  
plastique ABS antibactérien  
Autocentreer trechter in ABS  
plastic met bacteriëndodende  
behandeling  
Selbstschliessender Trichter aus  
ABS Plastik mit antibakteriellen  
Behandlung

Corpo esterno in ottone cromato: il design  
universale si adatta ad ogni contesto  
Outer part in chrome plated brass: the  
universal design is suitable to any  
Cuerpo externo en latón cromado: el diseño  
universal se adapta a cualquier contexto  
Corps externe en laiton chromé: le design  
universel s'adapte à chaque coin wc  
Buitenste korpus in verchromd messing:  
het universele design past zich aan iedere  
situatie aan  
Aussenteil aus verchromten Messing: Dank  
dem universalen Design passt es sich jeder  
Umgebung an



41 cm

← 9 cm →

Ogni confezione singola è  
dotata di uno scovolo di  
ricambio  
Every single packet has a  
spare part brush  
Cada paquete individual  
está dotada de un cepillo de  
recambio  
Chaque boitage est doté  
d'une balayette de rechange  
Ledere enkele verpakking  
is uitgerust met een  
vervangende borstelkop  
Jede einzelne Verpackung  
wird mit einer Ersatzbürste  
ausgestattet

Scovolo  
Brush  
Cepillo  
Balayette  
Borstelkop  
Bürste

A3814A CR

Base in plastica polipropilene: evita il  
danneggiamento delle superfici e garantisce  
una maggiore silenziosità durante l'appoggio  
Basement in polypropylene plastic: avoid the  
damaging of surface areas and guarantees a  
quiet set down  
Base en plástico polipropileno: evita se dañe  
la superficie y garantiza un mayor silencio  
durante el apoyo  
Socle en plastique polypropylène: respect des  
surfaces et silence  
Onderkant in polypropyleen plastic: vermijdt  
beschadigingen van de oppervlakten en  
garandeert het geluidloos neerzetten van het  
product  
Boden aus Plastik: vermeidet die  
Beschädigung der Bodenoberflächen und  
garantiert eine leises Aufsetzen der Garnitur



### TRATTAMENTO ANTIBATTERICO

100% di igiene grazie al nuovo trattamento antibatterico delle parti in polipropilene. La sostanza igienizzante viene inserita direttamente nella materia prima garantendo l'eterna durata del trattamento.

### ANTIBACTERIAL TREATMENT

100% hygienical thanks to the new antibacterial treatments of the polypropylene parts. The substance is placed directly into the basic material ensuring the eternal duration of treatment.

### TRATAMIENTO ANTIBACTERIANO

100% higiénico gracias al nuevo tratamiento antibacteriano de las partes en polipropileno. La sustancia higienizante se aplica directamente a la materia prima, garantizando la duración eterna del tratamiento.

### TRAITEMENT ANTIBACTÉRIEN

100% hygiénique grâce au traitement antibactérien des parties en polypropylène. La substance désinfectante est injectée directement dans la matière garantissant une durée éternelle du traitement.

### BACTERIËNDODENDE BEHANDELING

100% hygiene dankzij de nieuwe bacteriëndodende behandeling van de delen in polipropyleen. De hygiëniserende vloeistof wordt rechtstreeks door de grondstof opgenomen en garandeert zo de eeuwige werking van de behandeling.

### ANTIBAKTERIELLE BEHANDLUNG

100% Hygienegarantie dank der neuen antibakteriellen Behandlung der Polypropylenteile. Die hygienisierende Substanz wird direkt dem Grundstoff beigefügt, was eine dauerhafte Garantie gewährleistet.

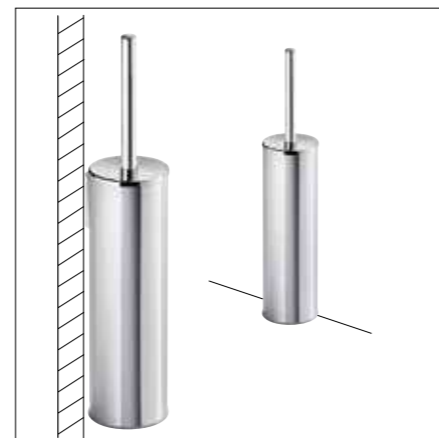

### FUNZIONALITÀ

Innovativo sistema autocentrante: la forma conica del coperchio facilita l'inserimento dello scovolo e assicura la corretta chiusura dello scopino.

### FONCTIONNEL

Système d'auto-centrage innovant: la forme conique du couvercle facilite l'emboîtement de la balayette et assure ainsi une fermeture parfaite du porte-balai.

### VERSATILITÀ

Lo stesso prodotto può essere utilizzato in appoggio o installato a parete poiché la placca per il fissaggio è sempre compresa nella confezione.

### POLYVALENT

Le même produit peut être aussi bien posé au sol que fixé au mur grâce à la pate de fixation incluse dans l'emballage.

### RICARICABILE

Sostituisci lo scovolo senza toccare le parti non igieniche: impugna il coperchio e ruota il manico. La parte intercambiabile si sgancia automaticamente consentendone la sostituzione.

### INTERCHANGEABLE

Remplacez la balayette facilement: tenez le couvercle et faite tourner le manche.

### FUNCTIONALITY

Innovative self-centering-system: the conical shape of the cover simplify the insertion of the brush and ensures proper closing of the toilet brush.

### DOELMATIGHEID

Innoverend autocentrerend systeem: de kegelvorm van het deksel vergemakkelijkt het insteken van de borstelkop en verzekert de correcte sluiting van de toiletborstelgarnituur.

### VERSATILITY

The same product is suitable as free-standing or wall mounted because the wall mounting plate is always included in the package.

### VEELZIJDIGHEID

Hetzelfde product kan zowel vrijstaand als aan de wand gebruikt worden gezien de bevestigingsplaat altijd inbegrepen is bij de verpakking.

### RECHARGEABLE

Replace the brush without touching any unsanitary part: holding the cover and turning the handle. The interchangeable part will be released automatically allowing the substitution.

### VERVANGING

Vervang de borstelkop zonder de niet hygiënische gedeeltes aan te raken: hou het deksel vast en draai de steel. Het deel dat vervangen kan worden zal automatisch loshaken om zo de vervanging mogelijk te maken.

### FUNCIONALIDAD

Innovativo sistema autocentrante: la forma cónica de la tapa facilita el inserción del cepillo y asegura el cierre correcto del escobillero.

### ZWECKMÄßIGKEIT

Neuartiges selbstschliessendes System: Dank des trichtersförmigen Deckels wird die Einführung der Bürste vereinfacht und eine korrekte Schliessung der Garnitur garantiert.

### VERSATILIDAD

El mismo producto puede ser utilizado de apoyo o instalado a la pared puesto que la placa de fijación viene incluida en la confección.

### VIELSEITIGKEIT

Der Artikel kann als Standmodell benutzt oder an die Wand montiert werden, da die Befestigungsplatte immer in der Verpackung dabei ist.

### RECARGABLE

Sustituye el cepillo sin tocar las partes no higiénicas: empuña la tapa y gira el mango. La parte intercambiable se desengancha automáticamente consintiendo la sustitución.

### AUSTAUSCHBAR

Tauschen Sie die Bürste aus, ohne die nicht hygienischen Teile anzufassen: Fassen Sie den Deckel an und drehen Sie den Stiel. Das austauschbare Teil wird automatisch ausgeklingt und erlaubt so den Austausch.

26\_ **ELLEPI**  
design GREY ID



\_27



**CR**  
Cromato  
Chrome-plated  
Cromado  
Chromé  
Verchromd  
Verchromt



**WM**  
Bianco opaco  
Mat white  
Blanco mate  
Blanc mat  
Mat wit  
Matt Weiß



**NE**  
Nero opaco  
Mat black  
Negro mate  
Noir mat  
Mat zwart  
Matt Schwarz



**NZ**  
Nickel spazzolato/cromato  
Brushed nickel/chrome-plated  
Níquel cepillado/cromado  
Nickel brossé/chromé  
Geborsteld nikkel/verchromd  
Nickel, gebürstet/Verchromt







A4418A CR  
A4418A WM  
A4418A NE  
A4418A NZ  
cm 35 x 5H x 8

A4418B CR  
A4418B WM  
A4418B NE  
A4418B NZ  
cm 50 x 5H x 8



A4418C CR  
A4418C WM  
A4418C NE  
A4418C NZ  
cm 65 x 5H x 8

A4418D CR  
A4418D WM  
A4418D NE  
A4418D NZ  
cm 85 x 5H x 8



A44160 CR  
A44160 WM  
A44160 NE  
A44160 NZ  
cm 22 x 18H x 8



A44200 CR  
A44200 WM  
A44200 NE  
A44200 NZ  
cm 5 x 8H x 5



A44110 CR 21  
A44110 WM 21  
A44110 NE 21  
A44110 NZ 21  
cm 13 x 5H x 14



A44100 CR 21  
A44100 WM 21  
A44100 NE 21  
A44100 NZ 21  
cm 9 x 12H x 13



0,25 Lt.

A44120 CR 21  
A44120 WM 21  
A44120 NE 21  
A44120 NZ 21  
cm 9 x 16H x 12



A4425A CR  
A4425A WM  
A4425A NE  
A4425A NZ  
cm 17 x 5H x 9

30



A44260 CR  
A44260 WM  
A44260 NE  
A44260 NZ  
cm 15 x 14H x 6

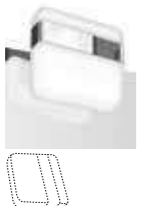

IP44 CE  
LED REV  
AV012G AL  
cm 20 x 20H x 8  
220/240V - 50/60Hz  
15W



AV014A CR  
AV014A WM  
cm Ø 9 x 40H



AV014B CR  
AV014B NE  
AV014B AC  
cm Ø 9 x 40H



R10000



31

32\_ **EGO**  
design Matteo Thun and Antonio Rodriguez





34\_ EGO



\_35



**A1318A CR**  
cm 33 x 3H x 8

**A3318B CR**  
cm 48 x 3H x 8  
**A3318C CR**  
cm 63 x 3H x 8



**A1320A CR**  
cm 3 x 3H x 4



**A1320B CR**  
cm 3 x 3H x 7



**A1320C CR**  
cm 3 x 7H x 4





**A20110 CR 21**  
cm 13 x 4H x 14 



**A20100 CR 21**  
cm 8 x 10H x 12 



**A20120 CR 21**  
cm 8 x 15H x 13  



**A1325A CR**  
cm 16 x 7H x 9



**A1325D CR**  
cm 16 x 7H x 9



**AV426D CR**  
cm 32 x 3H x 8



**A1328A CR**  
cm 3 x 16H x 8



**AV426F CR**  
cm 16 x 8H x 12



**AV426E CR**  
cm 33 x 4H x 12



**AV014A CR**  
cm Ø 9 x 40H 

36



**AV014B CR**  
cm Ø 9 x 40H 



**A13010 AL**  
cm Ø 22 x 25H  





**A13680 CR**  
cm 63 x 16H x 29



**A13950 CR**  
cm 35 x 3H x 7  



**A1390B CR**  
cm 50 x 3H x 7   
**A1390C CR**  
cm 63 x 3H x 7 



**A1351A CR**  
cm 27 x 4H x 11



**A1331A CR**  
cm 19 x 4H x 19



37



40\_ **CONFORT**  
design Matteo Thun and Antonio Rodriguez





**CR**  
Cromato  
Chrome-plated  
Cromado  
Chromé  
Verchromd  
Verchromt



**CU**  
Cromato/nero soft touch  
Chrome-plated/black soft touch  
Cromado/soft touch negro  
Chromé/noir soft touch  
Verchromd/zwart soft touch  
Verchromt/Schwarz soft touch





AH995A CR  
AH995A CU  
cm 44 x 8H x 9



AH995B CR  
AH995B CU  
cm 64 x 8H x 9



AH995C CR  
AH995C CU  
cm 74 x 8H x 9



AH992A CR  
AH992A CU  
cm 55 x 27H x 9



AH993C CR  
AH993C CU  
cm 67 x 67H x 9



AH993D CR  
AH993D CU  
cm 67 x 67H x 9



44\_



AH995F CR  
AH995F CU  
cm 144 x 8H x 9



AH996A CR  
AH996A CU  
cm 8 x 180H x 9



AH996B CR  
AH996B CU  
cm 8 x 180H x 9



AH994A CR  
AH994A CU  
cm 77 x 8H x 77



AH994B CR  
AH994B CU  
cm 77 x 8H x 77



\_45



AH993A CR  
AH993A CU  
cm 36 x 67H x 9



AH993B CR  
AH993B CU  
cm 36 x 67H x 9



AH994C CR  
AH994C CU  
cm 67 x 8H x 101

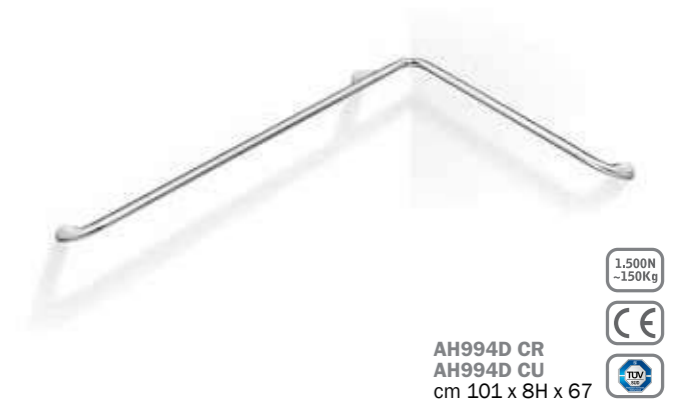

AH994D CR  
AH994D CU  
cm 101 x 8H x 67







**AH997C CR**  
cm 10 x 31H x 70



**AH925X CR**  
cm 5 x 15H x 17



**AH9K1A CR**  
cm 8 x 12H x 1,2



46\_

**AH997A CR**  
cm 10 x 31H x 60

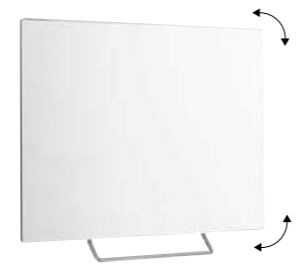

**AH9S5A CR**  
cm 80 x 66H x 11

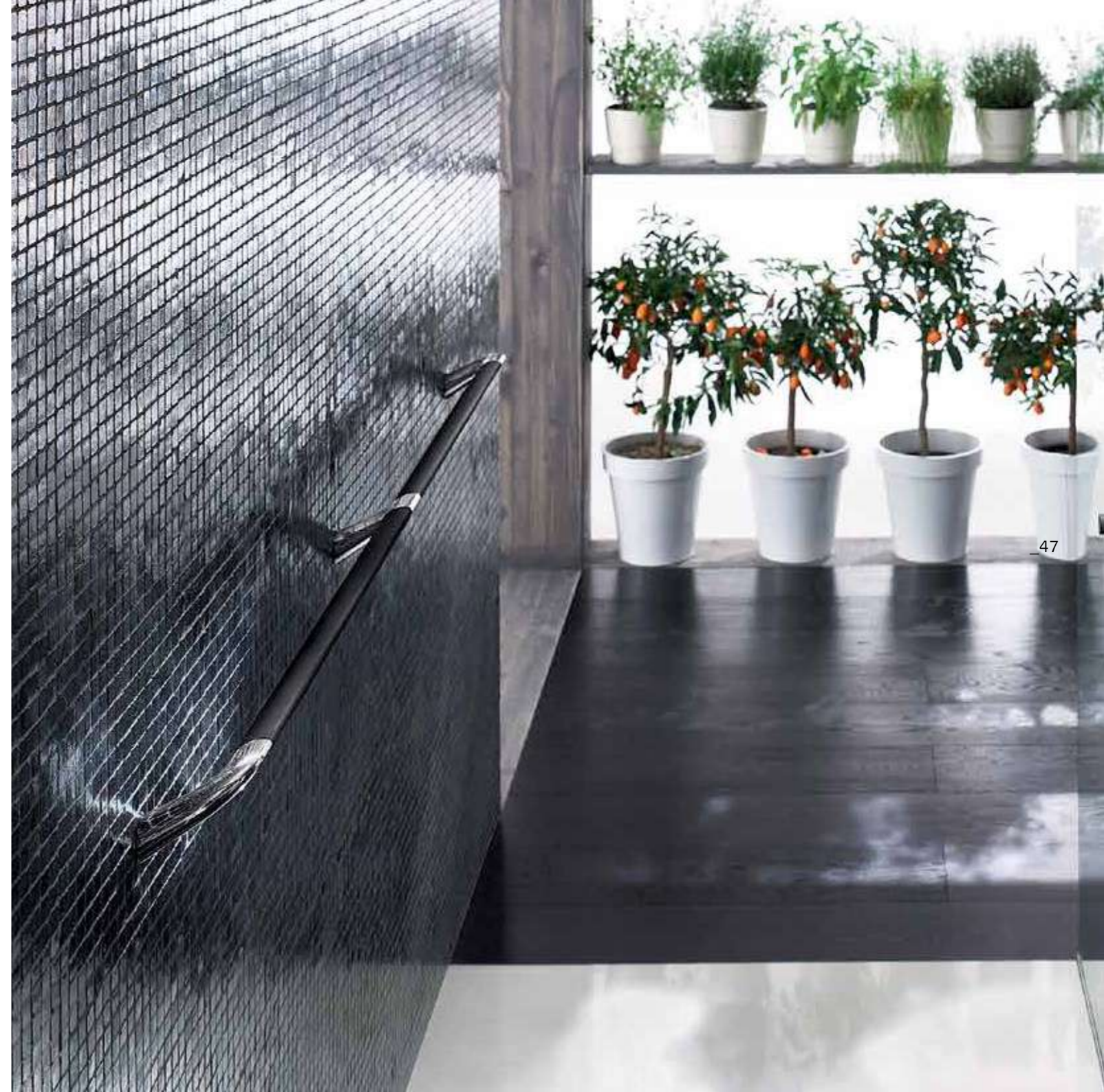

\_47

48\_ **NEW EUROPE**  
design STUDIO INDA



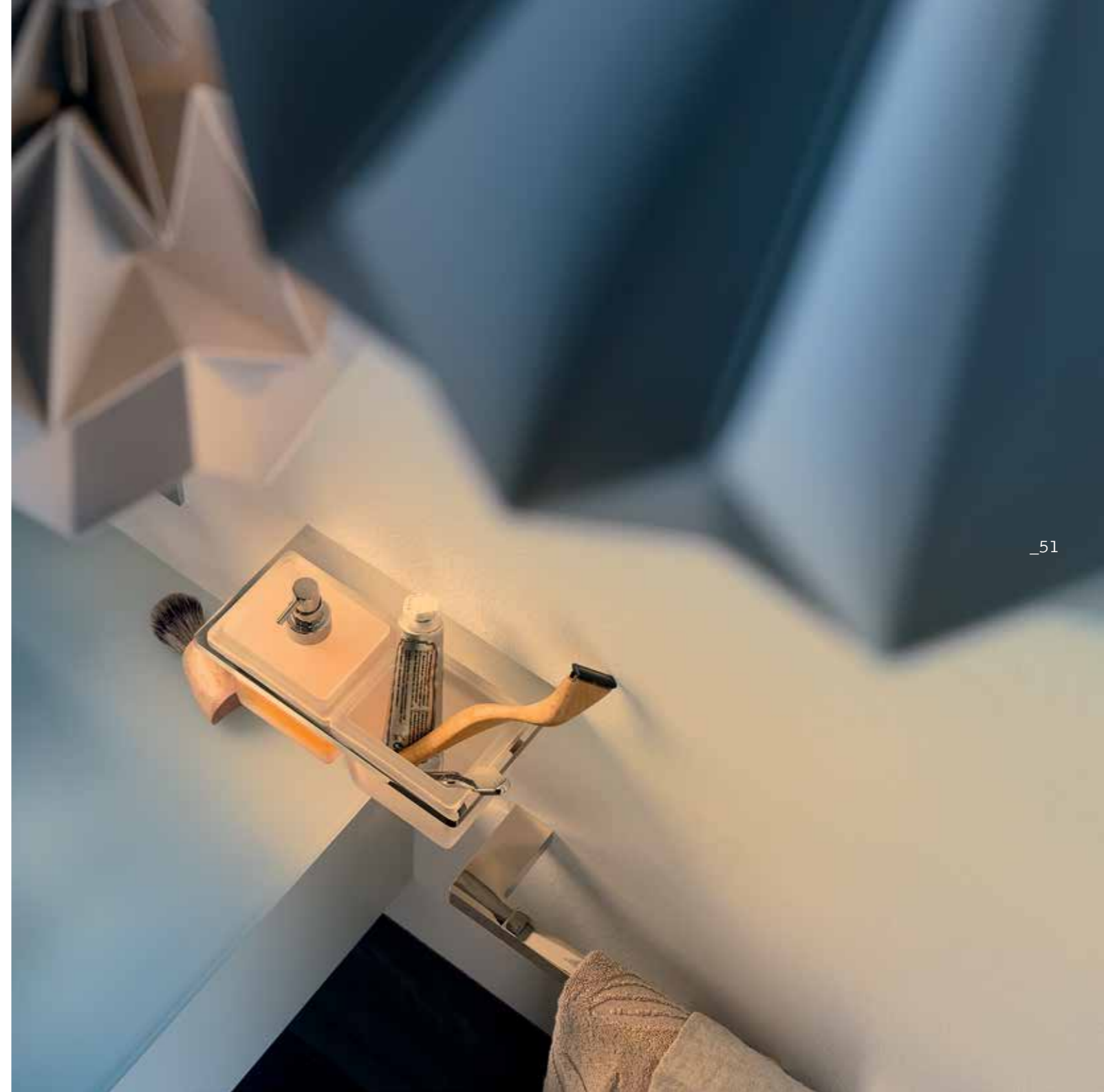
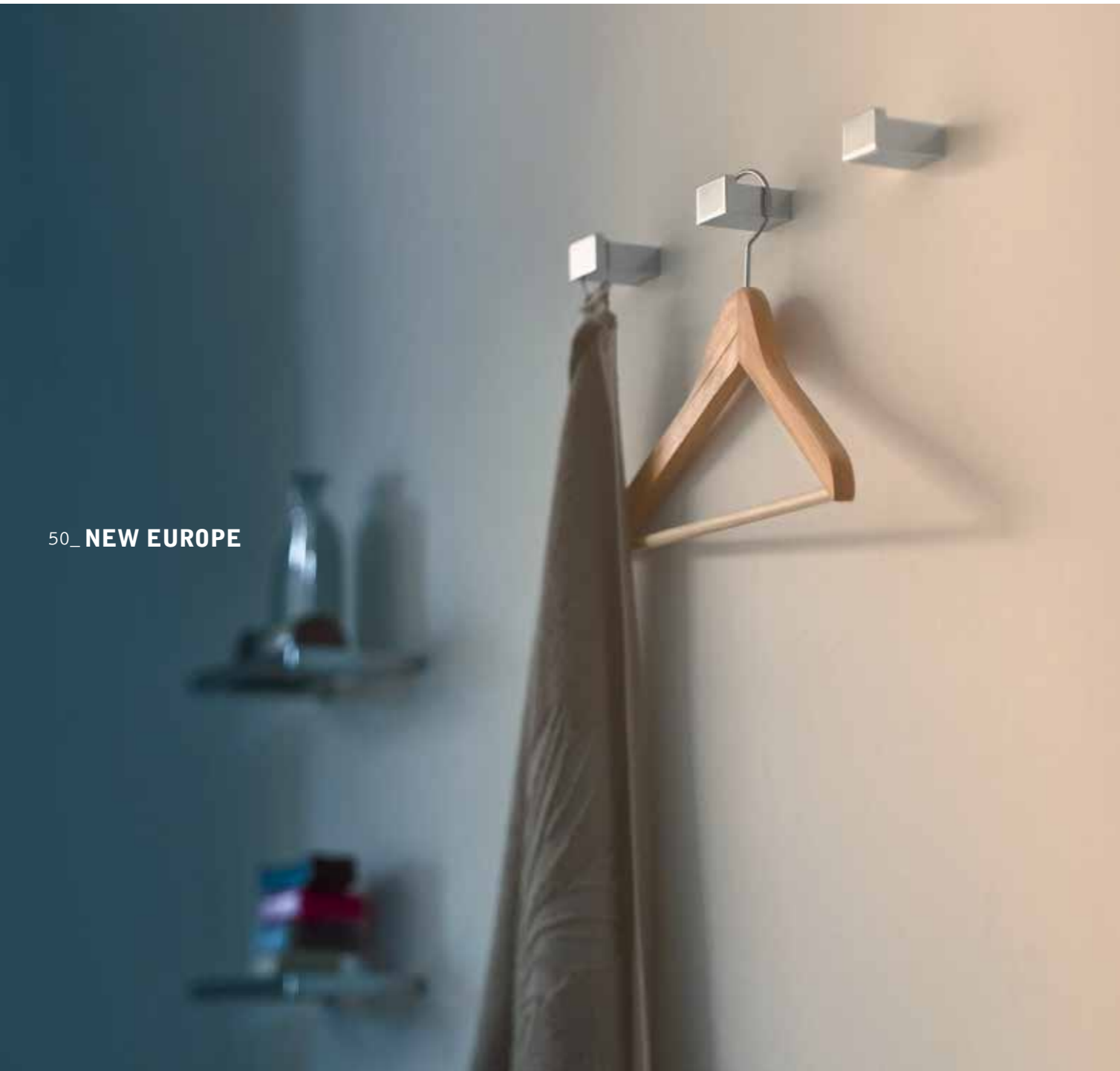



**A4918A CR**  
cm 34 x 2H x 9  
**A4918B CR**  
cm 49 x 2H x 9

click



**A4918C CR**  
cm 64 x 2H x 9  
**A4918D CR**  
cm 84 x 2H x 9

**A49160 CR**  
cm 24 x 2H x 13

click



**A33150 CR**  
cm 6 x 6H x 38



**A49200 CR**  
cm 4 x 3H x 5

click



**A49110 CR 21**  
cm 12 x 4H x 13

click



**A49100 CR 21**  
cm 12 x 10H x 13

click



**A49120 CR 21**  
cm 12 x 15H x 13

0,25 Lt.

click



**A4910M CR**  
cm 26 x 4H x 14



**A4983A CR 21**  
cm 81 x 4H x 14



**R49110**  
cm 11 x 2H x 9



**R49100**  
cm 11 x 10H x 9



**R49120**  
cm 11 x 15H x 9

0,25 Lt.



**A49250 CR**  
cm 16 x 3H x 8

click



**A4925A CR**  
cm 16 x 3H x 8

click



**A49260 CR**  
cm 15 x 10H x 6

click



**AV114A CR**  
cm 8 x 40H x 8



**A33950 CR**  
cm 30 x 3H x 5

1.500N  
~150Kg



**A3395B CR**  
cm 45 x 3H x 5  
**A3395C CR**  
cm 60 x 3H x 5

1.500N  
~150Kg



**A3395J CR**  
cm 45 x 2,8H x 5,3



**A3395K CR**  
cm 45 x 2,8H x 5,2



**AV0L2B CR**  
**AV0L2B AA**  
cm 28 x 5,5H x 14  
230V - 50Hz  
6W

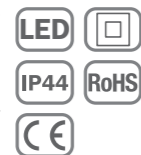

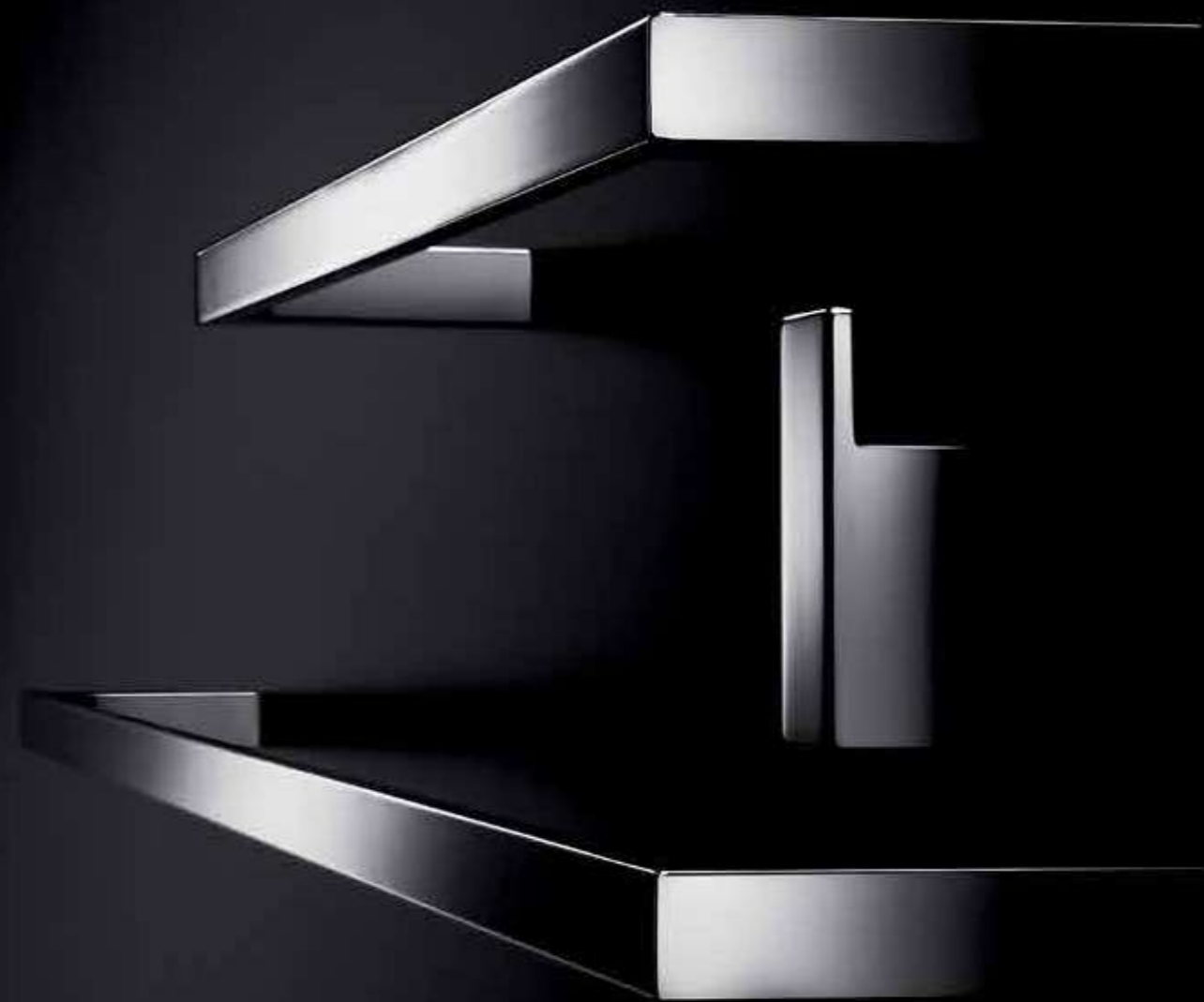



56\_ **DIVO**



**CR**  
Cromato  
Chrome-plated  
Cromado  
Chromé  
Verchromd  
Verchromt



**AC**  
Nickel spazzolato  
Brushed nickel  
Níquel cepillado  
Nickel brossé  
Geborsteld nikkel  
Nickel, gebürstet



\_57



**A1518A CR**  
**A1518A AC**  
cm 32 x 2H x 9

**A1518B CR**  
**A1518B AC**  
cm 47 x 2H x 9

**A1518C CR**  
**A1518C AC**  
cm 62 x 2H x 9  
**A1518D CR**  
**A1518D AC**  
cm 82 x 2H x 9



**A15150 CR**  
**A15150 AC**  
cm 2 x 8H x 39



**A1520A CR**  
**A1520A AC**  
cm 2 x 8H x 3



**A1510N CR**  
**A1510N AC**  
cm 11 x 2H x 11



**R1511B001**  
cm 11 x 4H x 11



**R1511B002**  
cm 11 x 4H x 11



**R1510B001**  
cm 8 x 11H x 8



**R1510B002**  
cm 8 x 11H x 8



**R1512B001**  
cm 9 x 16H x 8 0,25 Lt.



**R1512B002**  
cm 9 x 16H x 8 0,25 Lt.



**A2011Z CR 03**  
**A2011Z CR 21**  
**A2011Z AC 03**  
**A2011Z AC 21**  
cm 11 x 4H x 11



**A2010Z CR 03**  
**A2010Z CR 21**  
**A2010Z AC 03**  
**A2010Z AC 21**  
cm 9 x 11H x 9



**A2012Z CR 03**  
**A2012Z CR 21**  
**A2012Z AC 03**  
**A2012Z AC 21**  
cm 9 x 16H x 9 0,25 Lt.



**A1525A CR**  
cm 18 x 2H x 9

58



**A1525B CR**  
**A1525B AC**  
cm 18 x 2H x 9



**AV014A CR**  
**AV014A AC**  
cm Ø 9 x 40H



**AV014B CR**  
**AV014B AC**  
cm Ø 9 x 40H



**AV114A CR**  
**AV114A AC**  
cm 8 x 40H x 8



**A15490 CR**  
cm 20 x 2H x 11



**A15510 CR**  
cm 52 x 2H x 11



**A58960 CR**  
cm 8 x 17H x 13  
250V - 60W



59



60\_ **MITO**  
design STUDIO INDA



\_61





**CU**  
Cromato/nero soft touch  
Chrome-plated/black soft touch  
Cromado/soft touch negro  
Chromé/noir soft touch  
Verchromd/zwart soft touch  
Verchromt/Schwarz soft touch



**CW**  
Cromato/bianco soft touch  
Chrome-plated/white soft touch  
Cromado/soft touch bianco  
Chromé/blanc soft touch  
Verchromd/wit soft touch  
Verchromt/Weiß soft touch



**CR**  
Cromato  
Chrome-plated  
Cromado  
Chromé  
Verchromd  
Verchromt



**NV**  
Nero soft touch  
Black soft touch  
Soft touch negro  
Noir soft touch  
Zwart soft touch  
Schwarz soft touch



**BW**  
Bianco soft touch  
White soft touch  
Soft touch bianco  
Blanc soft touch  
Wit soft touch  
Weiß soft touch



**AC**  
Nickel spazzolato  
Brushed nickel  
Níquel cepillado  
Nickel brossé  
Geborsteld nikkel  
Nickel, gebürstet





A2018A CR  
A2018A CU  
A2018A CW  
A2018A AC  
cm 34 x 2H x 8

A2018B CR  
A2018B CU  
A2018B CW  
A2018B AC  
cm 49 x 2H x 8

click

A2018C CR  
A2018C CU  
A2018C CW  
A2018C AC  
cm 64 x 2H x 8



A20150 CR  
A20150 CU  
A20150 CW  
A20150 AC  
cm 2 x 9H x 40



A20160 CR  
A20160 CU  
A20160 CW  
A20160 AC  
cm 28 x 16H x 8

click



A2020A CR  
A2020A NV  
A2020A BW  
A2020A AC  
cm 2 x 6H x 4

click



AV014B CR  
cm 6 x 4H x 20  
220/240V - 50/60 Hz - 6W



A2020B CR  
A2020B NV  
A2020B BW  
A2020B AC  
cm 9 x 3H x 4

click



A20110 CR 21  
A20110 AC 21  
cm 13 x 4H x 14

click



A20100 CR 21  
A20100 AC 21  
cm 8 x 10H x 12

click



A20120 CR 21  
A20120 AC 21  
cm 8 x 15H x 13

0,25 Lt.



A2011Z CR 03  
A2011Z AC 03  
A2011Z CR 21  
A2011Z AC 21  
cm 11 x 4H x 11



A2010Z CR 03  
A2010Z AC 03  
A2010Z CR 21  
A2010Z AC 21  
cm 9 x 11H x 9



A2012Z CR 03  
A2012Z AC 03  
A2012Z CR 21  
A2012Z AC 21  
cm 9 x 16H x 9

0,25 Lt.



A01020VB  
A01020VN  
cm 11 x 3H x 11



A01010VB  
A01010VN  
cm 7 x 11H x 7



A01060VB  
A01060VN  
cm 7 x 20H x 7

0,60 Lt.



A2010N CR  
A2010N AC  
cm 8 x 2H x 12

click



R1511B001  
cm 11 x 4H x 11



R1511B002  
cm 11 x 4H x 11



R1510B001  
cm 8 x 11H x 8



R1510B002  
cm 8 x 11H x 8



R1512B001  
cm 9 x 16H x 8

0,25 Lt.



R1512B002  
cm 9 x 16H x 8

0,25 Lt.



A2025A CR  
A2025A CU  
A2025A CW  
A2025A AC  
cm 17 x 3H x 8

click



A2025B CR  
A2025B CU  
A2025B CW  
A2025B AC  
cm 17 x 3H x 8

click



A2028A CR  
A2028A CU  
A2028A CW  
A2028A AC  
cm 2 x 17H x 8

click



AV427A CR  
AV427A CU  
AV427A CW  
cm 13 x 8H x 13



A20260 CR  
A20260 CU  
A20260 CW  
A20260 AC  
cm 15 x 10H x 5

click



AV014A CR  
AV014A WY  
cm Ø 9 x 40H



AV014B CR  
AV014B NC  
AV014B AC  
cm Ø 9 x 40H



AV114A CR  
AV114A AC  
cm 8 x 40H x 8

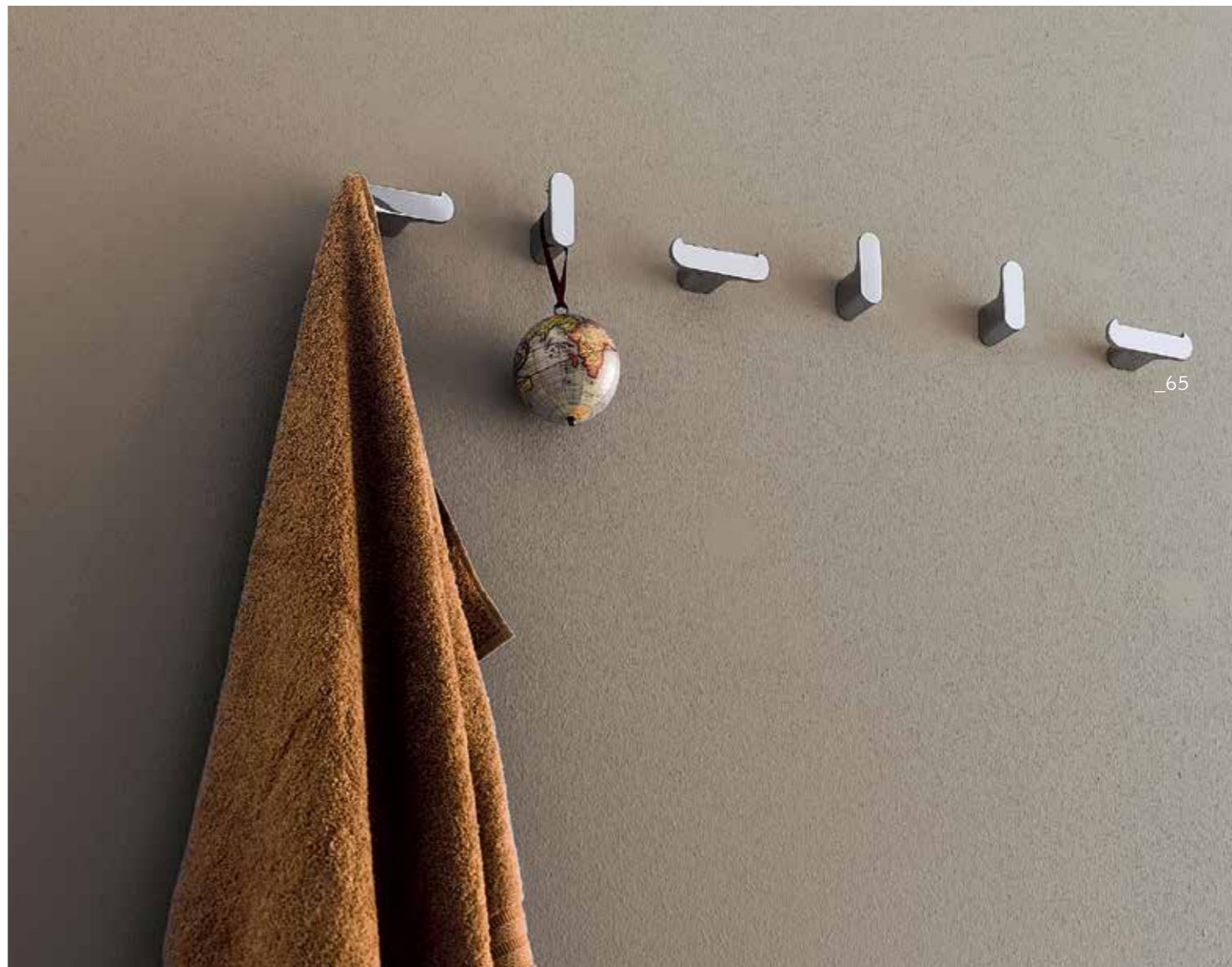



68\_ **GEALUNA**  
design STUDIO INDA



\_69



70\_ GEALUNA



\_71



**A1018A CR**  
cm 35 x 5H x 9  
**A1018B CR**  
cm 50 x 5H x 9



**A1018C CR**  
cm 65 x 5H x 9  
**A1018D CR**  
cm 85 x 5H x 9



**A1019B CR**  
cm 50 x 5H x 12  
**A1019C CR**  
cm 65 x 5H x 12

**A10150 CR**  
cm 37 x 9H x 5



**A10160 CR**  
cm 18 x 20H x 6



**A1020C CR**  
cm 7 x 6H x 6



**A1020A CR**  
cm 5 x 5H x 6



**A1020B CR**  
cm 15 x 5H x 5



**A10110 CR 03**  
cm 13 x 6H x 15



**A1010A CR 03**  
cm 8 x 11H x 13



**A10120 CR 03**  
cm 8 x 16H x 13



**A1025D CR**  
cm 18 x 5H x 9



**A1025A CR**  
cm 18 x 5H x 9



**A1025C CR**  
cm 29 x 5H x 9



**A10280 CR**  
cm 5 x 18H x 9



72



**A1025B CR**  
cm 14 x 5H x 6



**A10260 CR**  
cm 16 x 15H x 6



**AV014A CR**  
cm Ø 9 x 40H



**AV014B CR**  
cm Ø 9 x 40H



**A10680 CR**  
cm 65 x 12H x 29



**A10950 CR**  
cm 36 x 5H x 7  
1500 N (~150 kg)



**A1095B CR**  
cm 51 x 5H x 7  
**A1095C CR**  
cm 66 x 5H x 7  
1500 N (~150 kg)



**A36920 CR**  
cm 43 x 22H x 12



**A1051A CR**  
cm 35 x 5H x 13



**A1351A CR**  
cm 27 x 4H x 11



**A1051B CR**  
cm 29 x 3H x 13



**A1031A CR**  
cm 20 x 6H x 21



**A1031B CR**  
cm 21 x 2H x 21



**A1331A CR**  
cm 19 x 4H x 19



73



**A13010 AL**  
cm Ø 22 x 25H



**R10000**











**A1818A CR**  
cm 36 x 3H x 8  
**A1818B CR**  
cm 51 x 3H x 8

**A1818C CR**  
cm 66 x 3H x 8  
**A1818D CR**  
cm 86 x 3H x 8



**A1819B CR**  
cm 51 x 3H x 13  
**A1819C CR**  
cm 66 x 3H x 13



**A1815A CR**  
cm 7 x 3H x 38



**A18160 CR**  
cm 22 x 14H x 6



**A18310 CR**  
cm 16 x 7H x 18



**A18090 CR 21**  
cm 60 x 3H x 13



**R1800N0001**  
cm 6 x 3H x 0,8



**AVOL2B CR**  
**AVOL2B AA**  
cm 28 x 5,5H x 14  
230V - 50Hz  
6W

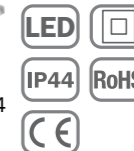

**A1820A CR**  
cm 6 x 3H x 5



**A1820B CR**  
cm 11 x 3H x 5



**A1820C CR**  
cm 17 x 3H x 5



**A18110 CR 21**  
cm 12 x 5H x 14



**A18100 CR 21**  
cm 7 x 11H x 11



**A18120 CR 21**  
cm 7 x 16H x 11



**A1811Z CR 21**  
cm 12 x 5H x 12



**A1810Z CR 21**  
cm 7 x 11H x 7



**A1812Z CR 21**  
cm 7 x 15H x 8



**A1810F CR 21**  
cm 20 x 10H x 11

80



**A1810D CR 21**  
cm 20 x 16H x 11



**A1825A CR**  
cm 19 x 3H x 8



**A18250 CR**  
cm 19 x 3H x 8



**A1825B CR**  
cm 31 x 3H x 8



**A18280 CR**  
cm 6 x 14H x 8



**A18260 CR**  
cm 15 x 10H x 6



**A19260 CR**  
cm 17 x 4H x 11



**A18140 CR 21**  
cm 10 x 35H x 14



**AV114A CR**  
cm 8 x 40H x 8



**A18680 CR**  
cm 66 x 9H x 25



**A33950 CR**  
cm 30 x 3H x 5



**A3395B CR**  
cm 45 x 3H x 5  
**A3395C CR**  
cm 60 x 3H x 5



**A1849A CR**  
cm 15 x 3H x 10



**A1851A CR**  
cm 25 x 3H x 12



**A18510 CR**  
cm 20 x 6H x 14



81





84\_ **HOTELLERIE**  
design STUDIO INDA

HOTELLERIE

inda®  



\_85





**A0590M CR**  
cm 32 x 7H x 8



**A0490T CR**  
cm 33 x 8H x 7



**A0490F CR**  
cm 53 x 8H x 7



**A0490C CR**  
cm 68 x 8H x 7



**A0491T CR**  
cm 43 x 22H x 12



**A0492T CR**  
cm 43 x 22H x 12

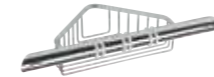

**A04620 CR**  
cm 35 x 7H x 25

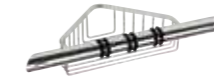

**A0462A CR**  
cm 35 x 7H x 25



**A04610 CR**  
cm 35 x 3H x 3



**A0461A CR**  
cm 35 x 3H x 3



**A1051B CR**  
cm 29 x 3H x 13



**A1351A CR**  
cm 27 x 4H x 11



**A04500 CR**  
cm 13 x 4H x 10



**A04510 CR**  
cm 20 x 4H x 12



**A0451H CR**  
cm 20 x 7H x 13



**AV051A CR**  
cm 29 x 9H x 14

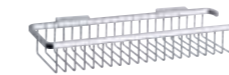

**A0453H CR**  
cm 39 x 7H x 14



**A1031B CR**  
cm 21 x 2H x 21



**A0431V CR 21**  
cm 24 x 4H x 24



**A04310 AL 02**  
cm 17 x 10H x 17



**A1331A CR**  
cm 19 x 4H x 19



**A04490 CR**  
cm 16 x 4H x 16



**A0449H CR**  
cm 17 x 7H x 17



**AV031A CR**  
cm 22 x 9H x 22



**A04320 AL 02**  
cm 17 x 31H x 18



**AV032A CR**  
cm 22 x 38H x 22



**AV408A CR 01**  
cm 60 x 3H x 16



**AV408B CR 01**  
cm 60 x 5H x 16



**RV408A**  
cm 3 x 3H x 2



**A1809N CR**  
cm 6 x 3H x 2



**R1150A**  
cm 60 x 0,6H x 12



**R11509**  
cm min. 50 - max. 100 x 0,6H x 12



**A04660 CR**  
cm Ø10 - L 4→250



**A04030 AL**  
cm 5 x 7H x 4



**AV058P CR**  
cm 20 x 41H x 15



**AV058Q CR**  
cm 20 x 41H x 16



**A0458D CR**  
cm Ø 18 x 2



**AV058E CR**  
cm Ø 20 x 26



**AV058F CR**  
cm 20 x 20H x 26



**A0458A CR**  
cm Ø 18 x 26



**AV058L CR**  
cm 20 x 20H x 40



**AV058M CR**  
cm 20 x 20H x 40



**AV058C CR**  
cm 23 x 27H x 35



**A0458C CR**  
cm Ø 18 x 41



**A0458E CR**  
cm 18 x 47H x 19



**AV058H CR**  
cm 25 x 25H x 30  
220-240V - 6W



**AV158A CR**  
cm Ø 23 x 31  
230V - 1x11W



90





\_91







**Finiture / Finishes / Acabados / Finitions / Afwerkingen / Ausführungen**

**CR**  
  
 Cromato  
 Chrome-plated  
 Cromado  
 Chromé  
 Verchroomd  
 Verchromt

**DL**  
  
 Cromato / smoke  
 Chrome-plated / smoke  
 Cromado / smoke  
 Chromé / smoke  
 Verchroomd / smoke  
 Verchromt / smoke

**CA**  
  
 Cromato / miel  
 Chrome-plated / miel  
 Cromado / miel  
 Chromé / miel  
 Verchroomd / miel  
 Verchromt / miel

**AL**  
  
 Acciaio Inox  
 Stainless steel  
 Acero inoxidable  
 Acier Inoxydable  
 Roestvrij staal  
 Inox Gebürsteter

**AP**  
  
 Alluminio lucido  
 Polished aluminium  
 Aluminio brillante  
 Aluminium brillant  
 Glanzend aluminium  
 Glänzend Aluminium

**SL**  
  
 Silver  
 Silver  
 Plata  
 Silver  
 Zilver  
 Silber

**NV**  
  
 Nero soft touch  
 Black soft touch  
 Soft touch negro  
 Noir soft touch  
 Zwart soft touch  
 Schwarz soft touch

**CW**  
  
 Cromato / bianco soft touch  
 Chrome-plated / white soft touch  
 Cromado / blanco soft touch  
 Chromé / blanc soft touch  
 Verchroomd / swit soft touch  
 Verchromt / weiß soft touch

**BW**  
  
 Bianco soft touch  
 White soft touch  
 Blanco soft touch  
 Blanc soft touch  
 Swit soft touch  
 Weiß soft touch

**WC**  
  
 Bianco / cromo  
 White / chrome  
 Blanco / cromado  
 Blanc / chromé  
 Wit / verchroomd  
 Weiß / verchromt

**SN**  
  
 Silver / nero  
 Silver / black  
 Plata / negro  
 Silver / noir  
 Zilver / zwart  
 Silber / schwarz

**NE**  
  
 Nero opaco RAL 9004  
 Mat black RAL 9004  
 Negro mate RAL 9004  
 Noir mat RAL 9004  
 Mat zwart RAL 9004  
 Matt Schwarz RAL 9004

94

**CD**  
  
 Cromato / dorato  
 Chrome-plated / gilded  
 Cromado / dorado  
 Chromé / doré  
 Verchroomd / verguld  
 Verchromtes / vergoldet

**DR**  
  
 Dorato 24 carati  
 Gilded 24 carats  
 Dorado 24 quilates  
 Doré 24 carats  
 Verguld 24 karaat  
 Goldfarben 24 karat

**BZ**  
  
 Bronzo  
 Bronzed  
 Bronze  
 Bronze  
 Verbronsd  
 Bronzefarben

**WM**  
  
 Bianco opaco RAL 9016  
 Mat white RAL 9016  
 Blanco mate RAL 9016  
 Blanc mat RAL 9016  
 Mat wit RAL 9016  
 Matt weiß RAL 9016

**AC**  
  
 Nickel spazzolato  
 Brushed nickel  
 Níquel cepillado  
 Nickel brossé  
 Geborsteld nikkel  
 Nickel, gebürstet

**NZ**  
  
 Nickel spazzolato / cromato  
 Brushed nickel / chrome-plated  
 Níquel cepillado / cromado  
 Nickel brossé / chromé  
 Geborsteld nikkel / verchroomd  
 Nickel, gebürstet / verchromt

**CU**  
  
 Cromato / nero soft touch  
 Chrome-plated / black soft touch  
 Cromado / soft touch negro  
 Chromé / noir soft touch  
 Verchroomd / zwart soft touch  
 Verchromt / Schwarz soft touch

**WZ**  
**WW**  
  
 Bianco lucido RAL 9016  
 Glossy white RAL 9016  
 Blanco brillante RAL 9016  
 Blanc brillant RAL 9016  
 Glanzend wit RAL 9016  
 Weiß glänzend RAL 9016

**NS**  
  
 Acciaio inox spazzolato AISI 304  
 Brushed stainless steel AISI 304  
 Acero inoxidable cepillado AISI 304  
 Acier inoxydable brossé AISI 304  
 RVS geborsteld AISI 304  
 Edelstahl AISI 304, Gebürstet

**WY**  
  
 Bianco opaco / cromato  
 Mat white / chrome-plated  
 Blanco mate / cromado  
 Blanc mat / chromé  
 Mat wit / verchroomd  
 Matt weiß / verchromt

**NC**  
  
 Nero opaco / cromato  
 Mat black / chrome-plated  
 Negro mate / cromado  
 Noir mat / chromé  
 Mat zwart / verchroomd  
 Matt schwarz / verchromt

**CS**  
  
 Classic

95

**Finiture / Finishes / Acabados / Finitions / Afwerkingen / Ausführungen**

**ML** Militare



**RM** Rame



**CO** Carbonio



**GE** Geometric



96

**01** Vetro trasparente  
Transparent glass  
Vidrio transparente  
Verre transparent  
Transparant glas  
Transparentes Glas



**03**  
**001** Vetro extrachiario trasparente  
Extra clear transparent glass  
Vidrio extraclaro transparente  
Verre transparent extra clair  
Transparant glas extra helder  
Transparentes Glas, extraklar



**21**  
**002**  
**26** Vetro satinato  
Satined glass  
Vidrio satinado  
Verre satiné  
Gesatineerd glas  
Satinierteres Glas



**07** Ceramica bianca  
White ceramic  
Ceramica blanca  
Céramique blanche  
Wit porselein  
Weiß Keramik



**02** Polimetilmetacrilato  
Polymethyl methacrylate  
Polimetilmetacrilado  
Polyméthacrylate de méthyle  
Polymetylmetacriilaat  
Polymethylmethacrylat



\_97





**Legenda simboli / Symbol key / Leyenda símbolos  
Leyenda símbolos / Verklaring symbolen / Zeichenerklärung**

 Marchio CE  
CE mark  
Marca CE  
Label CE  
Merk CE  
CE Kennzeichnung

 Marchio CLASSE II  
CLASS II mark  
Marca CLASSE II  
Label CLASS II  
Merk CLASSE II  
CLASS II Kennzeichnung

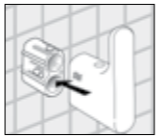
 Marchio TÜV  
TÜV mark  
Marca TÜV  
Label TÜV  
Merk TÜV  
TÜV Kennzeichnung

  

 Possibile installazione a muro mediante adesivo in pasta  
Possible wall-mounted installation with paste adhesive  
Posible instalación a pared mediante adhesivo en pasta  
Installation murale possible grâce à la colle prévue à cet effet  
Mogelijke installatie aan de wand door middel van kleefpasta  
Wandmontage: Möglich durch Klebstoffmasse

 Marchio VDE  
VDE mark  
Marca VDE  
Label VDE  
Merk VDE  
VDE Kennzeichnung

 Marchio SEV  
SEV mark  
Marca SEV  
Label SEV  
Merk SEV  
SEV Kennzeichnung

 Marchio RoHS  
RoHS mark  
Marca RoHS  
Label RoHS  
Merk RoHS  
RoHS Kennzeichnung

 Resistenza meccanica  
Mechanical resistance  
Resistencia mecánica  
Résistance mécanique  
Mechanische weerstand  
Mechanischen widerstand

 Capacità di contenimento  
Containment capacity  
Capacidad  
Capacité  
Capaciteit  
Kapazität

 Chiusura rallentata  
Soft closing  
Cierre ralentizado  
Fermeture rallentie  
Artikelen die losgemaakt  
Kunnen worden  
Soft Closing Schließung

 Marchio NEMKO  
NEMKO mark  
Marca NEMKO  
Label NEMKO  
Merk NEMKO  
NEMKO Kennzeichnung

 Grado di protezione degli involucri dei dispositivi elettrici  
Protection level of electrical devices' covering  
Grado de protección de los envoltorios de los dispositivos eléctricos  
Degré de protection des boîtiers des équipements électriques  
Beschermingsgraad van het omhulsel van de elektrische installatie  
Schutzgrad der Isolierungen der elektrischen Vorrichtungen

 Articoli sganciabili  
Removable products  
Artículos desenganchables  
Articles amovibles  
Artikelen die losgemaakt kunnen worden  
Auslauf Produkt

 Silenzioso  
Silent  
No ruido  
Silencieux  
Geruisloos  
Geräuschloser

 Tagliabile a misura  
Feasible to be cut at required  
measure  
Se puede cortar a medida  
Coupés à votre dimension  
Kan op maat gesneden worden  
Auf Maß zu kürzen

98

 Prodotto con interruttore  
Product with switch  
Artículo con interruptor  
Produit doté d'un interrupteur  
Product met schakelaar  
Produkt mit Schalter

 Prodotto con presa e interruttore  
Product with socket and switch  
Producto con enchufe e interruptor  
Produit avec prise et interrupteur  
Product met stopcontact en schakelaar  
Produkt mit Steckdose und Schalter

 Presa rasoio  
Razor socket  
Enchufe para rasurador  
Prise rasoir  
Stekker scheerapparaat  
Rasierstecker

 Bacinella con foro  
Soap-dish with hole  
Bandeja con orificio  
Coupelle percée  
Niet wegneembaar schaalje met gat  
Nicht herausnehmbare Schale  
Mit Bohrung

 Base antiscivolo  
Anti-slip base  
Base de deslizamiento  
Base antidérapante  
Anti-slip basis  
Anti-Rutsch-Basis

 Portasalviette carta da 350 pezzi  
Paper towel dispenser for 350 pcs  
Portaservilletas de papel para  
350 piezas  
Distributeur de serviettes pour  
350 pièces  
Tissuehouder voor 350 stuks  
Spender für 350 Stück

 Installazione reversibile  
Reversible installation  
Instalación reversible  
Installation réversible  
Omkeerbaare installatie  
Reversible installation

 Installazione non reversibile  
Irreversible installation  
Instalación no reversible  
Installation non réversible  
Installation non réversible  
Nicht reversible installation

 Articolo con chiave  
Article with key  
Artículo con llave  
Article avec clé  
Artikel met sleutel  
Artikel mit Schlüssel

 Lampada a incandescenza  
Incandescent lamp  
Lámpara a incandescencia  
Lampe à incandescence  
Gloeilamp  
Leuchtstofflampe

 Lampada fluorescente  
Fluorescent lamp  
Lámpara fluorescente  
Lampe fluorescente  
Fluorescente lamp  
Fluoreszierende Lampe

 Lampada alogena  
Halogen lamp  
Lámpara alógena  
Lampe halogène  
Halogene lamp  
Halogenlampe

 Prodotto ignifugo  
Fireproof product  
Artículo ignífugo  
Produit ignifuge  
Brandwerend product  
Feuerhemmendes Produkt

 Fattore di ingrandimento  
Magnifying factor  
Factor de aumento  
Facteur de grossissement  
Vergrotingsfactor  
Vergrößerungsfaktor

 Antibatterico  
Antibacterial  
Antibacteriano  
Antibactérien  
Bacteriëndodende behandeling  
Antibakteriell

 Illuminazione a led  
Led lighting  
Iluminación led  
Éclairage à led  
Led verlichting  
Led-beleuchtung

 Portata d'aria  
Air flow capacity  
Caudal de aire  
Puissance d'air  
Luchtbereik  
Luftzufuhr

 Potenza sonora  
Sound power  
Potencia sonora  
Puissante du bruit  
Geluidsdepend  
Lautstärke

99

Inda si riserva, a proprio insindacabile giudizio, di apportare modifiche anche senza preavviso, allo scopo di migliorare la produzione.

Inda reserves the right to modify the products without advance notice to improve production.

Inda se reserva el derecho de realizar, sin previo aviso, las modificaciones que considere convenientes para mejorar el producto.

Inda se réserve le droit, à tout moment et à son jugement sans appel, d'apporter des modifications sans préavis, afin d'améliorer la production.

Inda behoudt zich het recht voor te allen tijde en zonder voorafgaande kennisgeving wijzigingen aan te brengen, om het produkt te verbeteren.

Technische Änderungen zwecks Weiterentwicklung oder Verbesserung der Produkte vorbehalten.

INDA srl  
Single shareholder  
Subject to the Management and  
Coordination of Samo Industries S.r.l.

Operational Headquarters  
Via dell'Industria, 41  
I-24040 Pagazzano (BG)  
tel. +39 0363 38061  
fax. +39 0363 070035  
Administration +39 0363 740103

Bathroom Furniture  
Via Postumia Ovest, 72  
I-31050 Olmi di San Biagio di Callalta (TV)  
tel. +39 0422 7928  
fax. +39 0422 899688

[www.inda.net](http://www.inda.net)  
[info@inda.net](mailto:info@inda.net)

P.Iva: IT03868760962  
Registro Imprese MI: 03868760962  
Numero REA: MI - 1973214  
Capitale Sociale: Euro 300.000,00 i.v.



 **inda**<sup>®</sup>  
bathroom interiors



